

IN

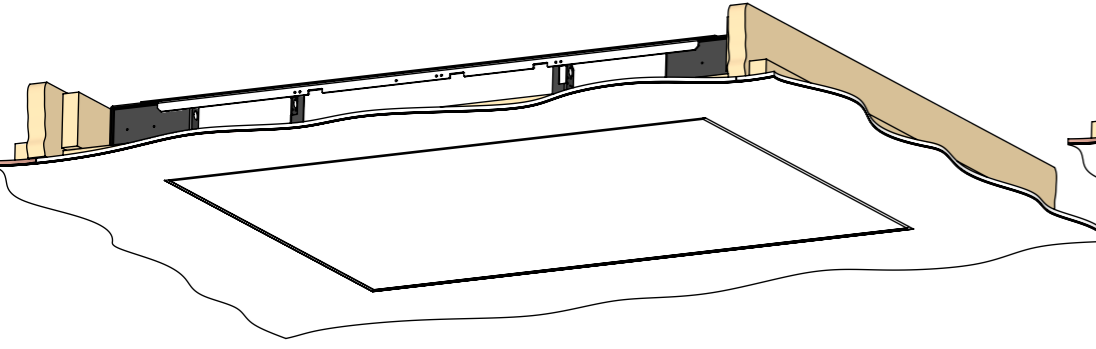

OUT 90 DEGREES

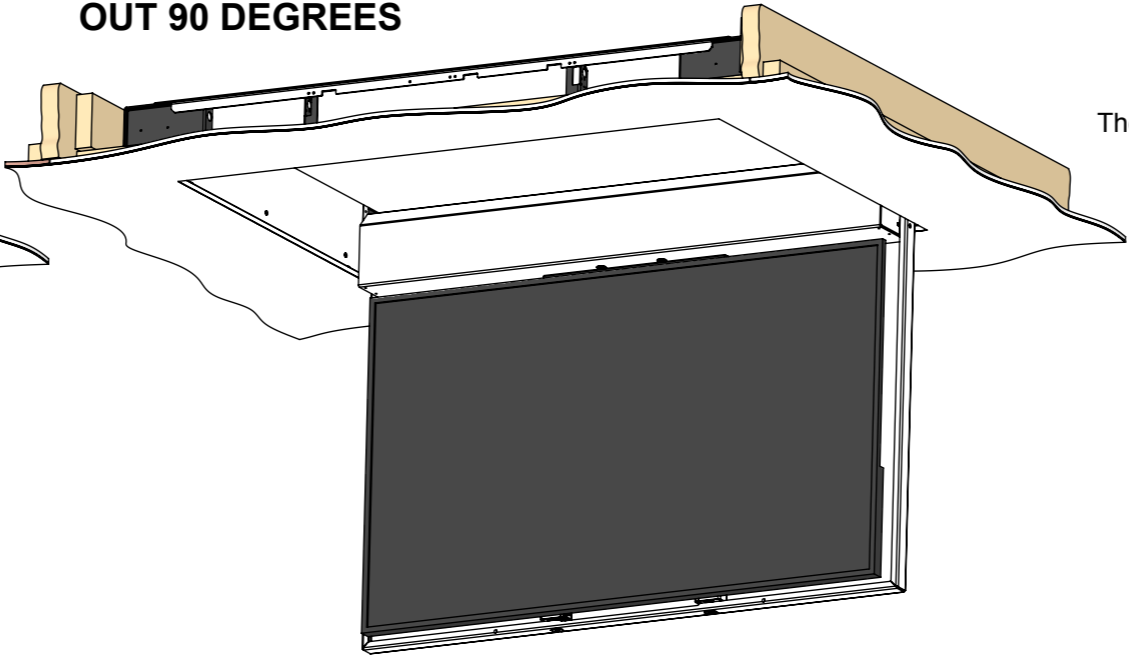

OUT 100 DEGREES

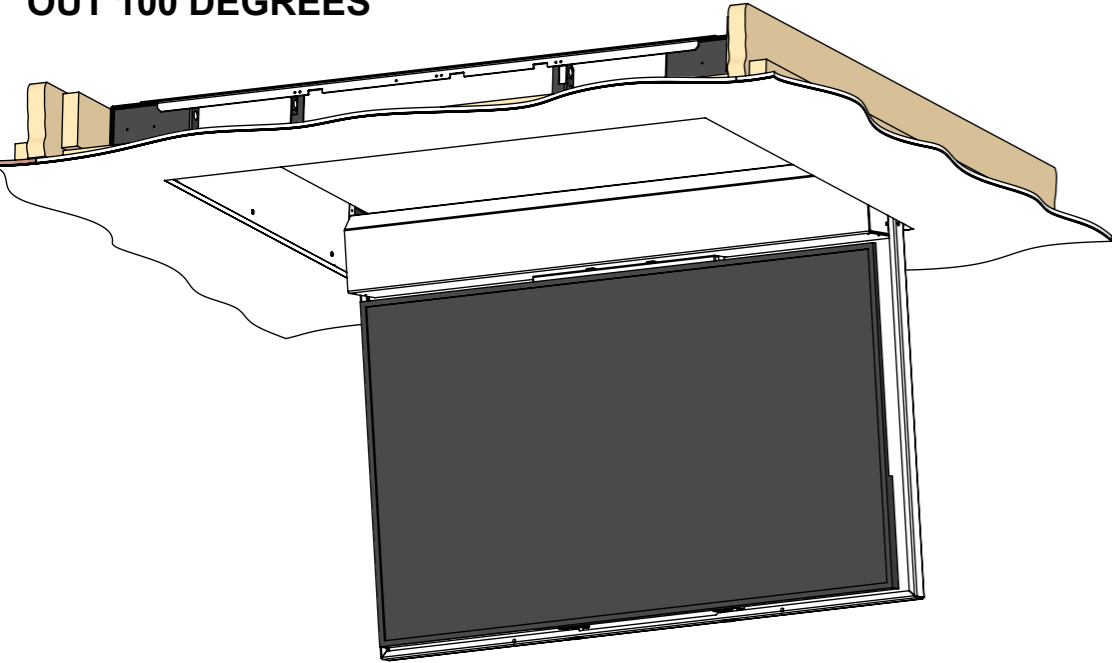

A motorised mechanism to reveal a display from the ceiling. This version hinges down by up to 100 degrees.

The size reference for this version is **CHR6-RES**.

The mechanism is fixed in place before the ceiling is finished. Supplied with MDF plaster edging to neatly plaster into the ceiling.

The control system can be operated via infra-red, RS232 or contact closure inputs.

Speakers can be added with the use of standard speaker mount brackets. (If required please specify during ordering process.)

See overview technical sheet for details on other products in the range.

Model Code	CHR6-RES
Max Screen Size	1530 [60.2] x 920 [36.2] x 100 [3.9]
Max Screen Weight	95kg [209lbs]
Approx Mechanism Weight	125kg [275lbs]
Environment	Residential
Colour	WHITE - RAL9910 Satin Finish
Control System	Accessible by internal access hatch
Mechanism Dimensions	2024 [79.7] W x 1305 [51.4] L x 210 [8.3] D

RESIDENTIAL MDF PLASTER EDGE

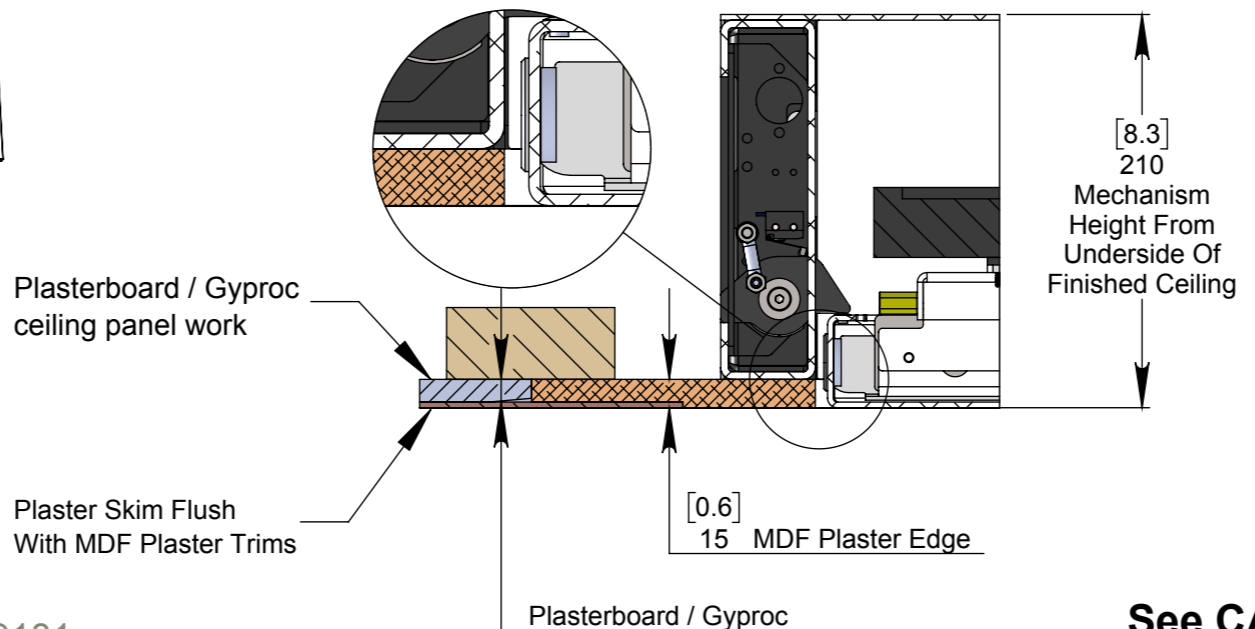

NOTE: This mechanism is not designed to accommodate additional panelwork on the main hinging tray. Please see **Tech Note - CHR-RES-AP Addon Panel Technical Note** for more information.

OPTION 1 - FIXING TO WOODEN BEAMS

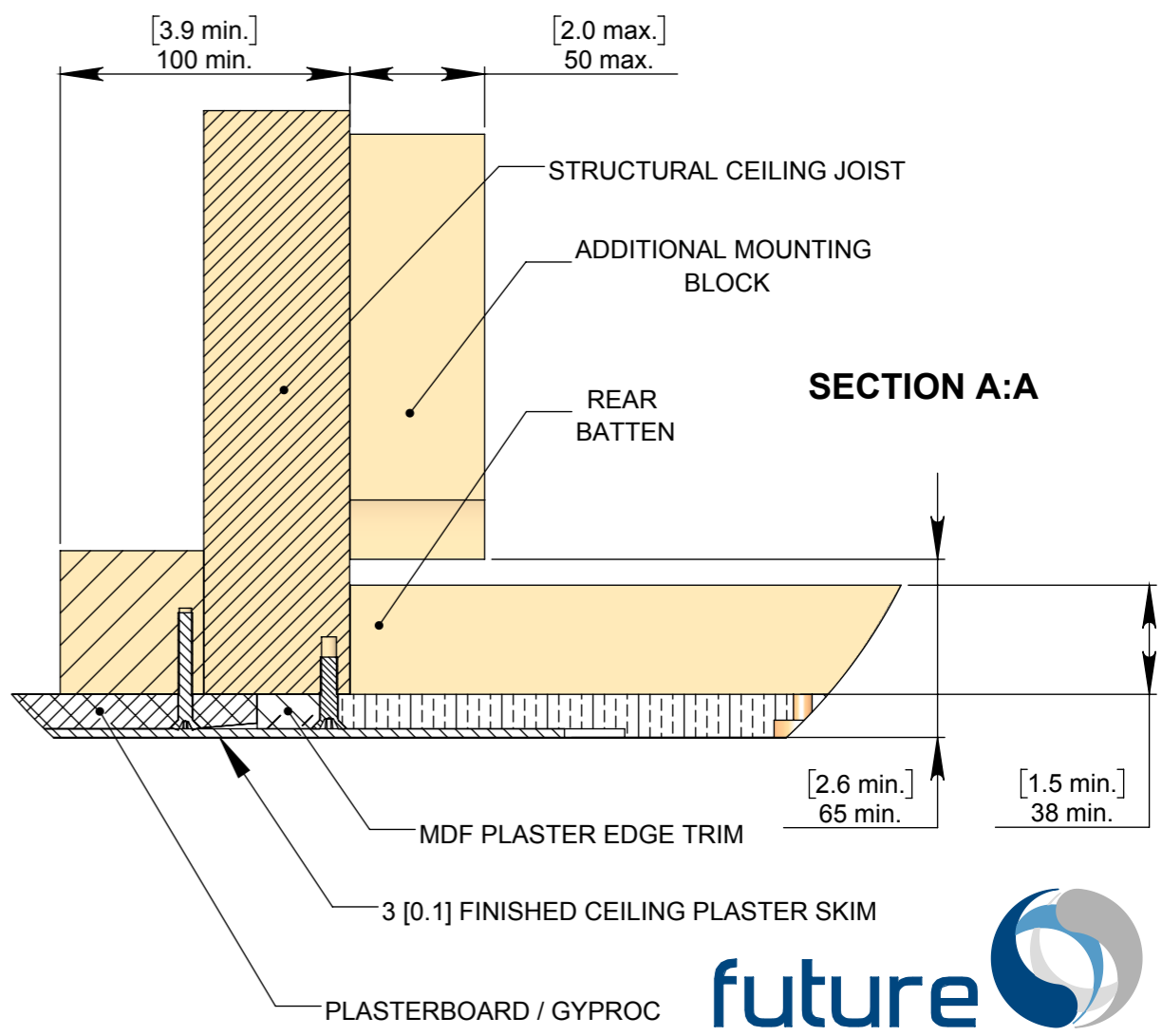
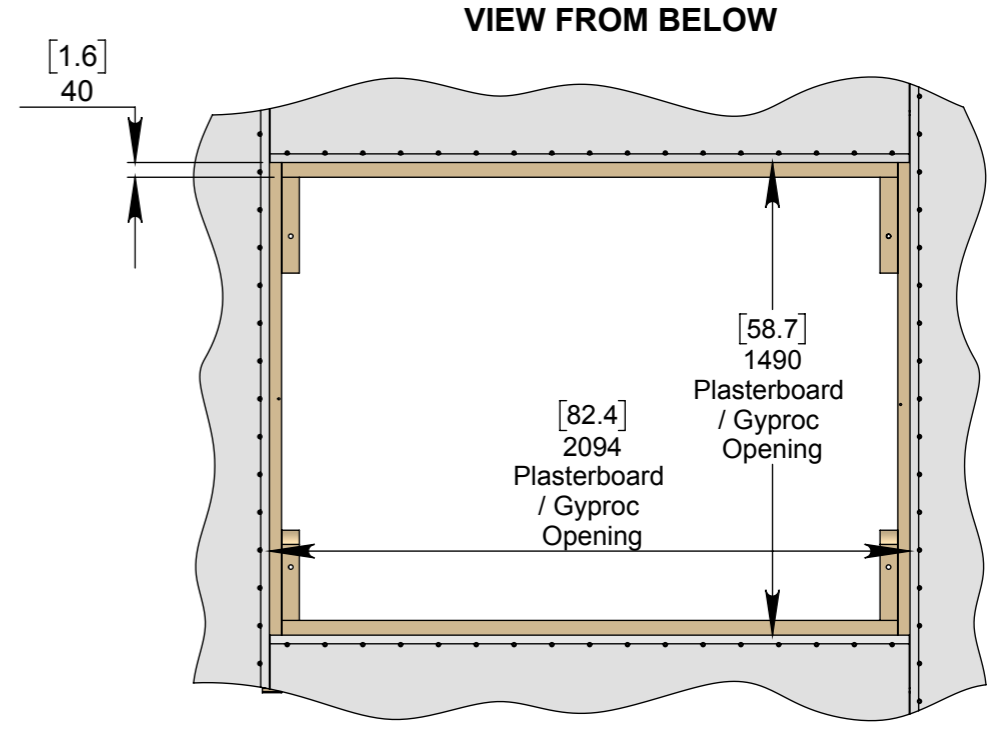
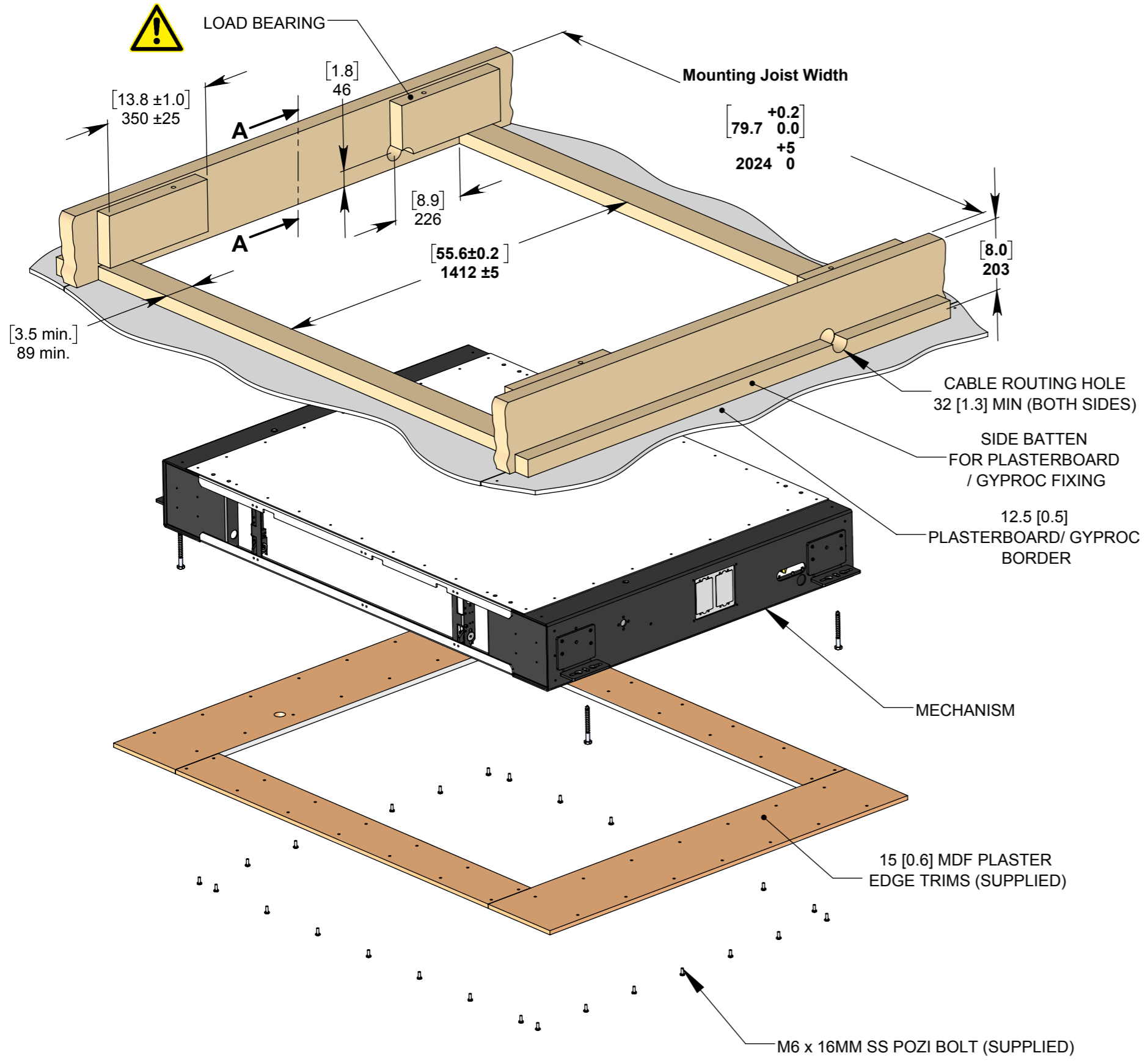

OPTION 2 - SUSPENDING FROM CEILING STRUCTURE ABOVE

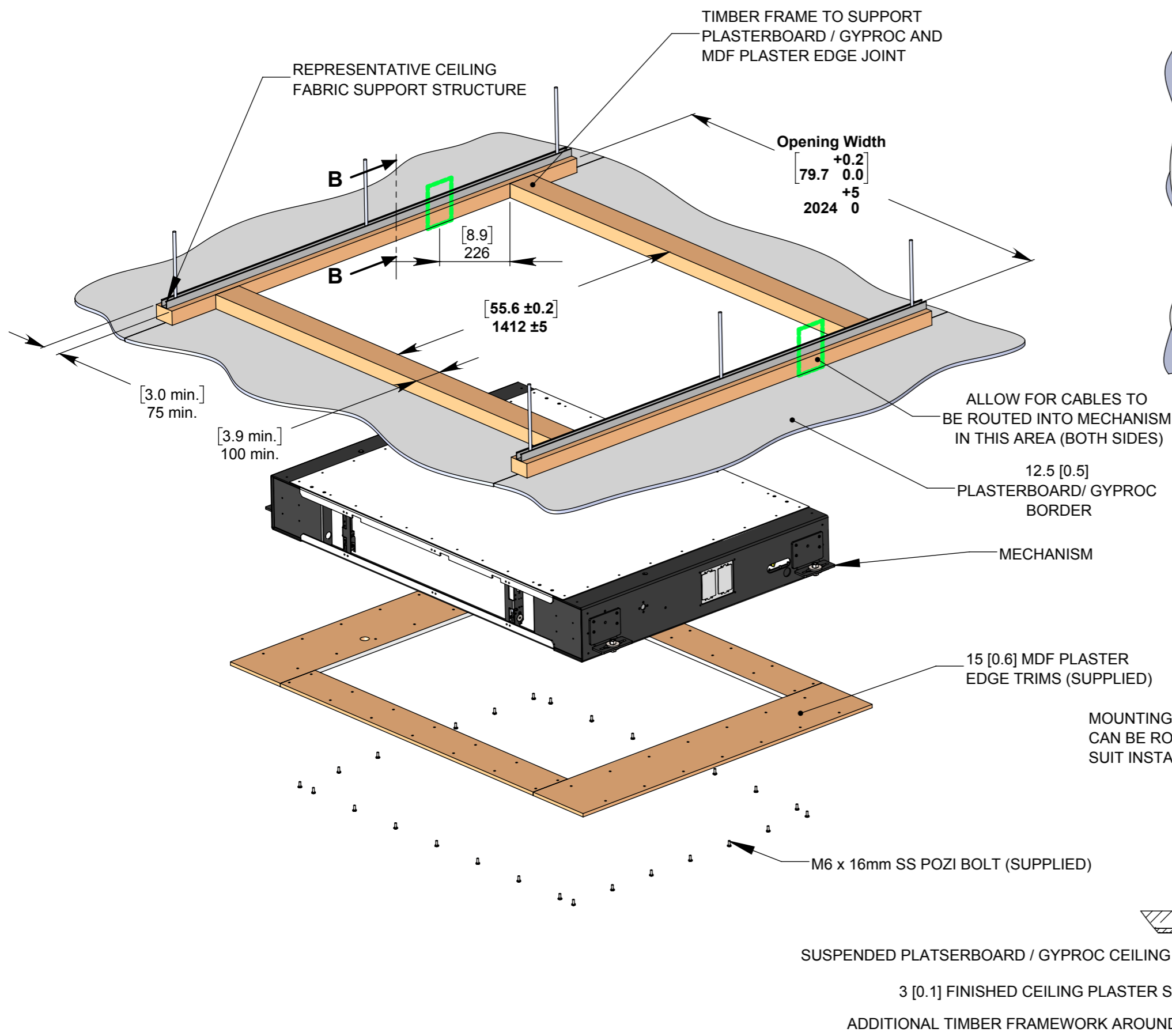

VIEW FROM BELOW

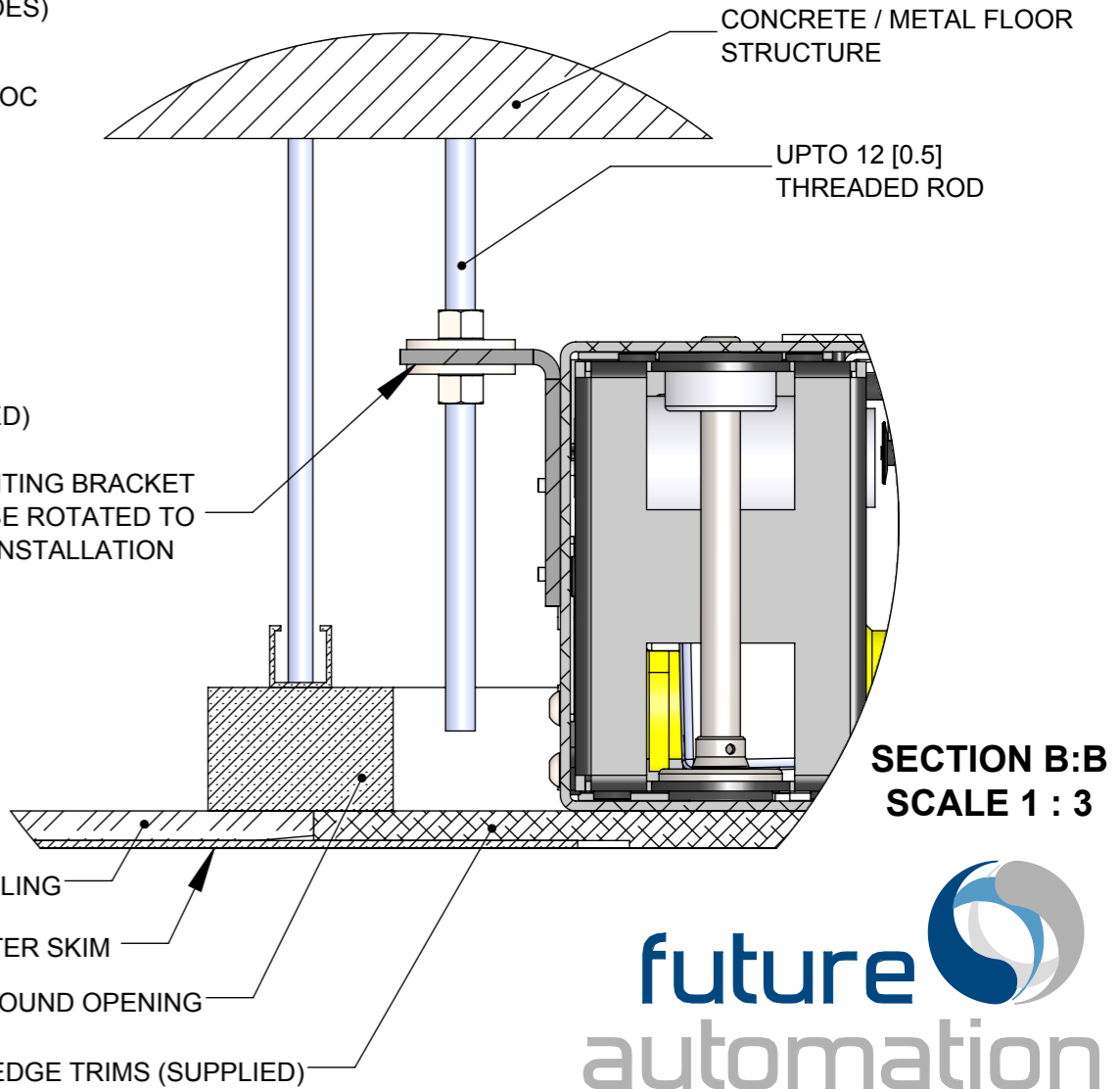
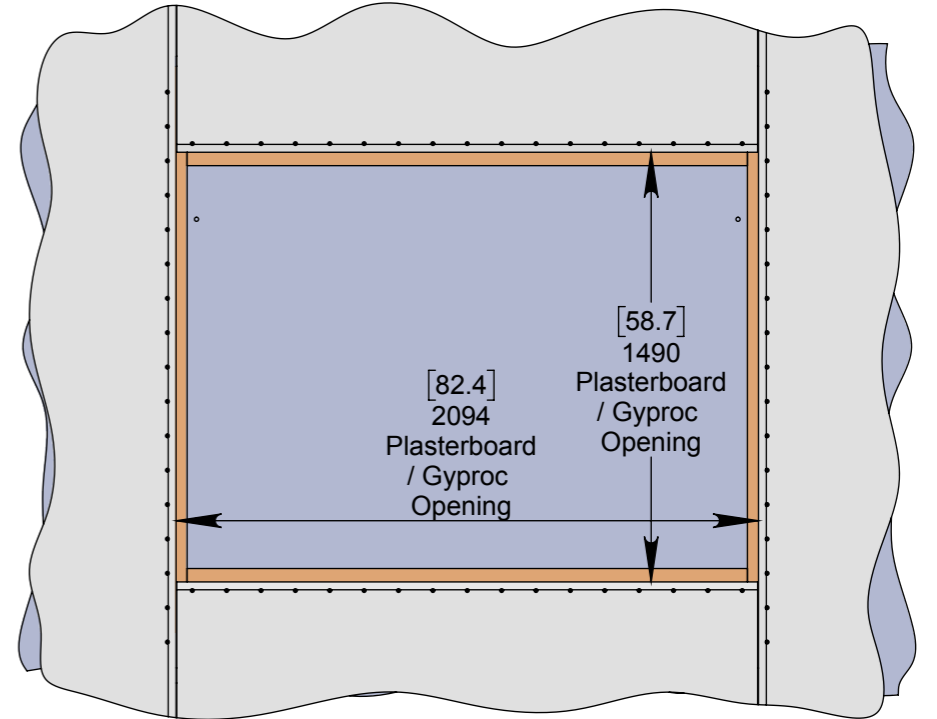

INSTALLATION PROCEDURE

1 Mechanism Installation

THE INSTALLATION PROCEDURE IS CARRIED OUT IN THE SAME WAY FOR OPTION 1 OR OPTION 2

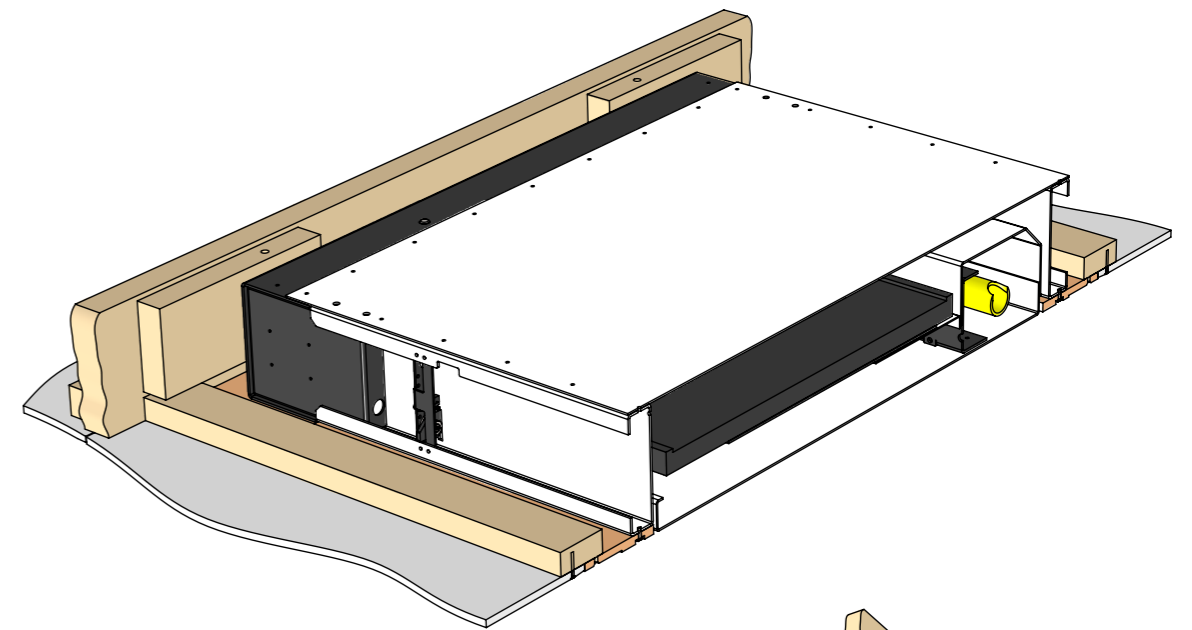
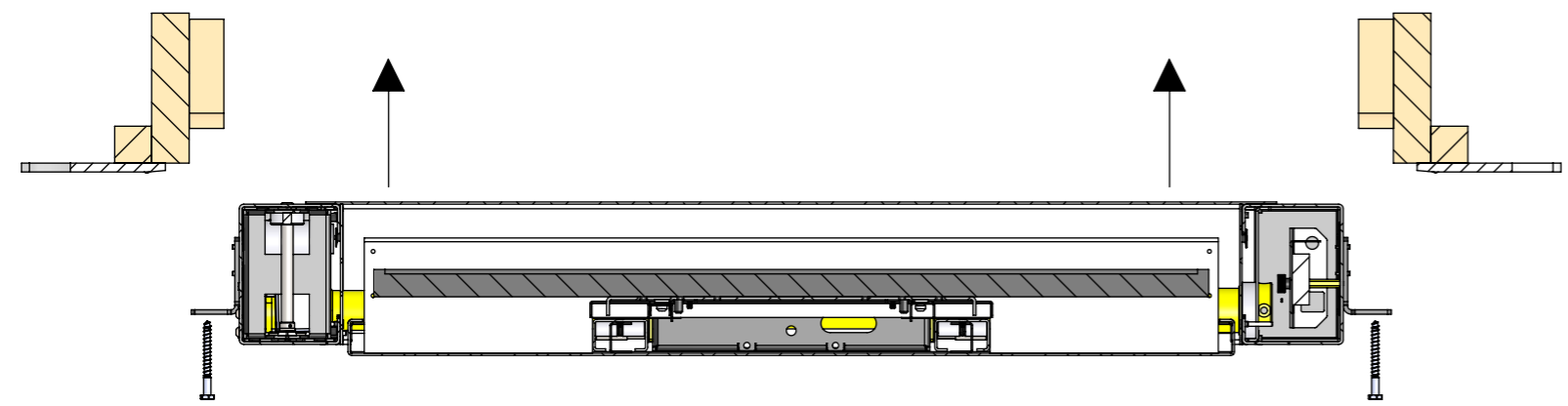

2 MDF Plaster Trim Installation

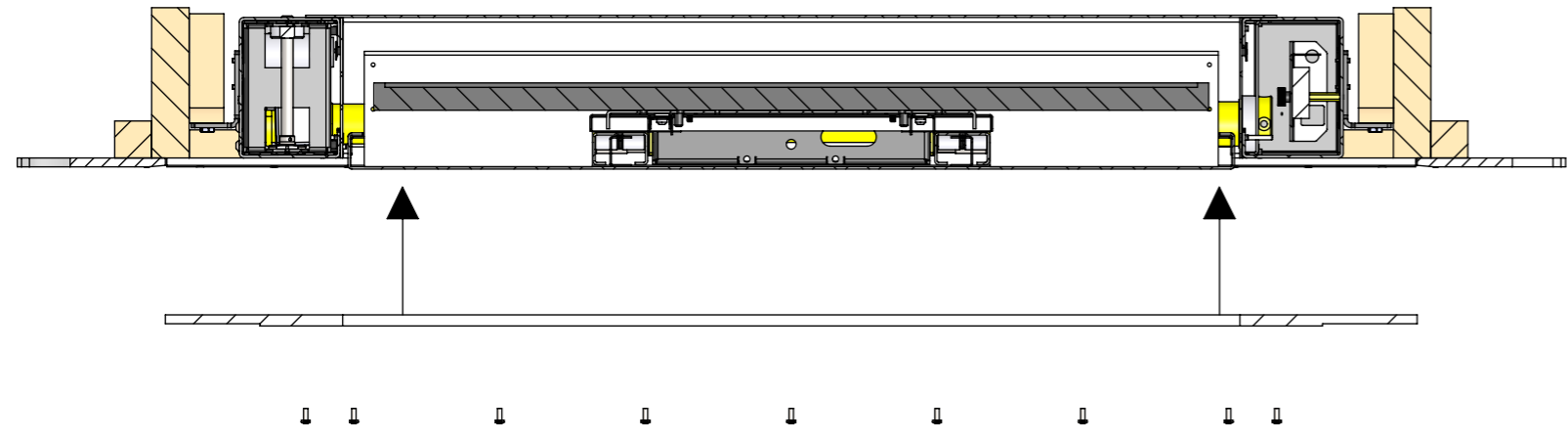

DETAIL A
SCALE 1 : 5

- 28 No. OFF SS M6 x 16MM POZI (SUPPLIED)
- 28 No. OFF MDF SCREW (NOT SUPPLIED)

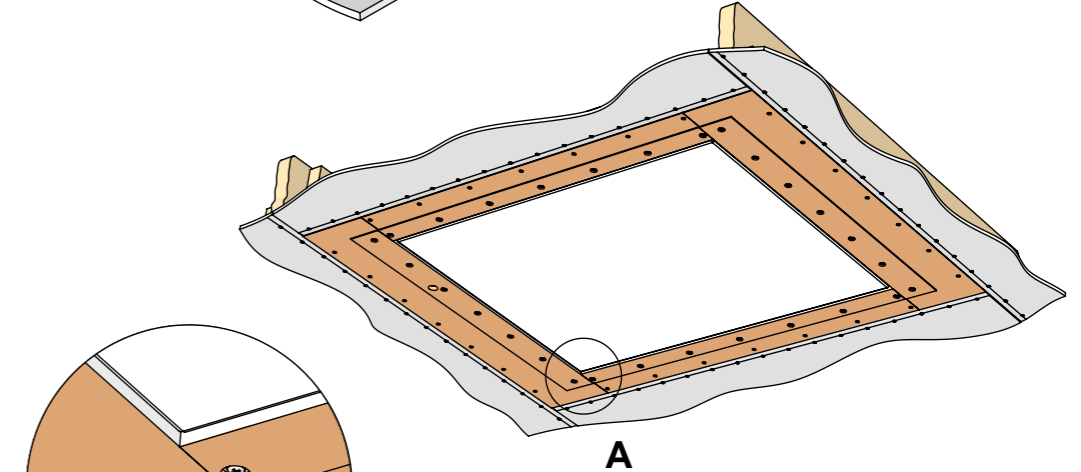

SUITABLE FIXING (NOT SUPPLIED)

3 Plastering

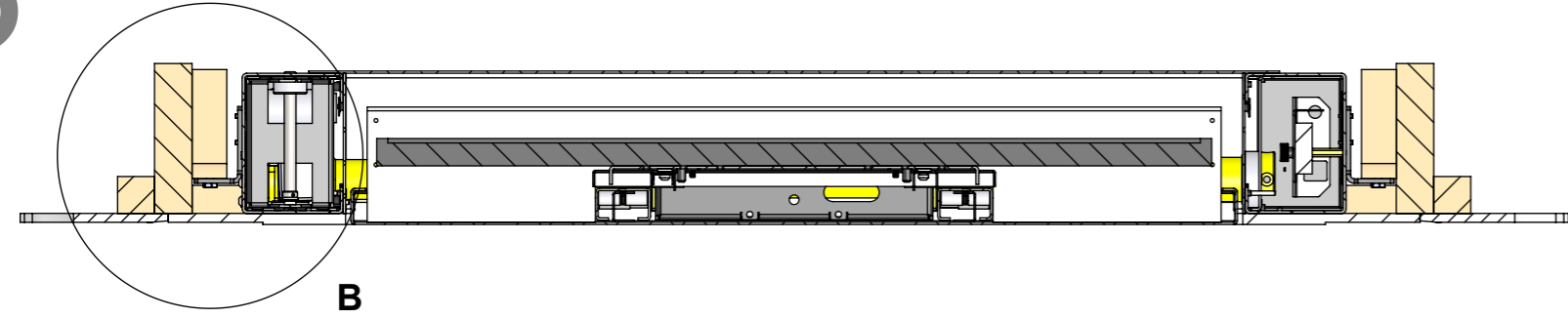

DETAIL B
SCALE 1 : 5

3 [0.1] FINISHED CEILING PLASTER SKIM

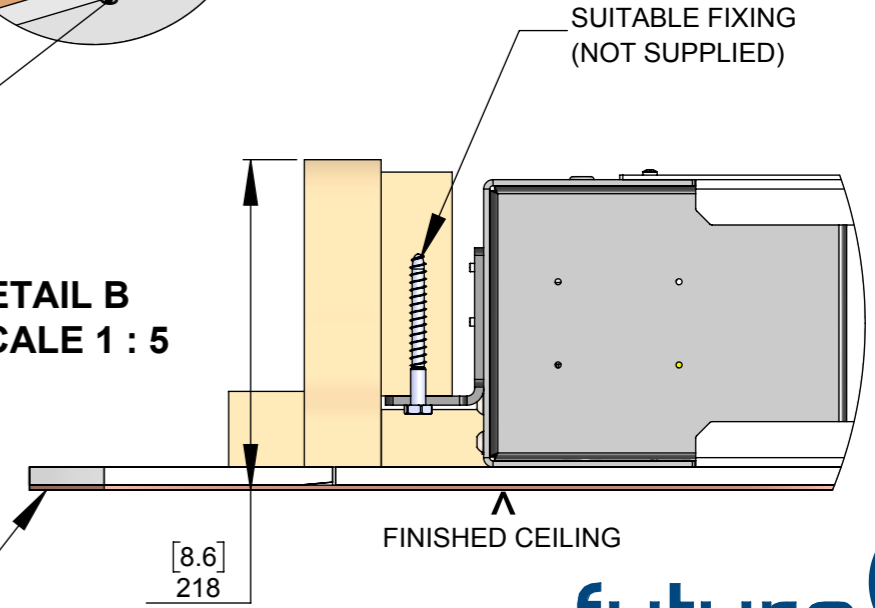

CEILING PREPERATION

— AV Signal Cables / Mechanism Control Cables
 - - - Power Cable for Mechanism and AV

Ensure Cables can be routed to / through ceiling joist / ceiling structure at these points into mechanism.

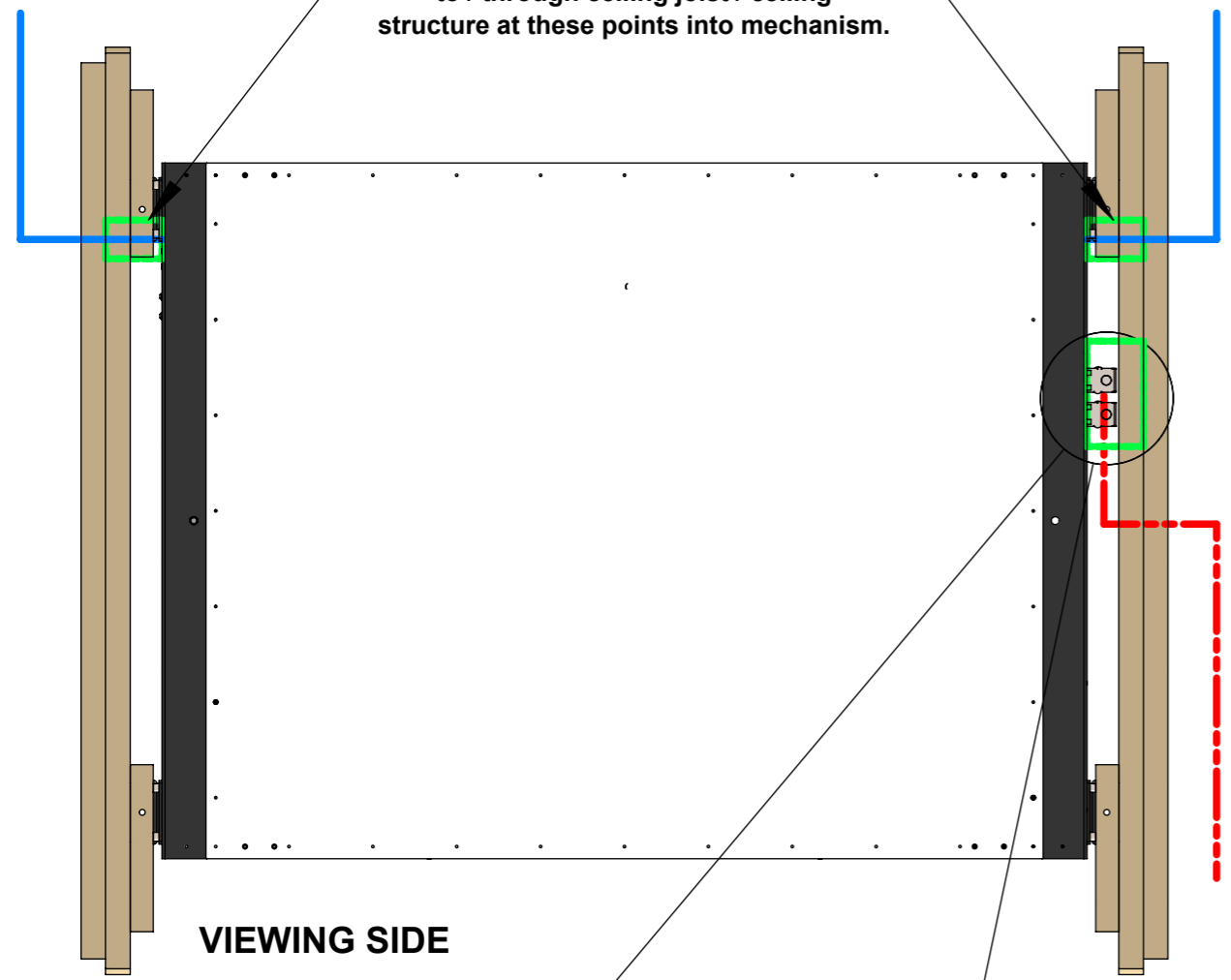

VIEWING SIDE

UK 2G Mains
Plasterboard
Back Box

2 No.
US J-Box

Cable Routing

Cables for the screen can be routed in from both sides, allowing for power and signal cables to be separated when entering the mechanism.

The opening on both sides is **MIN. 32mm [1.3"]** in diameter allowing for multiple cables to be routed to the screen.

A power outlet mounting plate is supplied in the right hand gearbox allowing for UK and US power outlets to be wired directly into the mechanism.

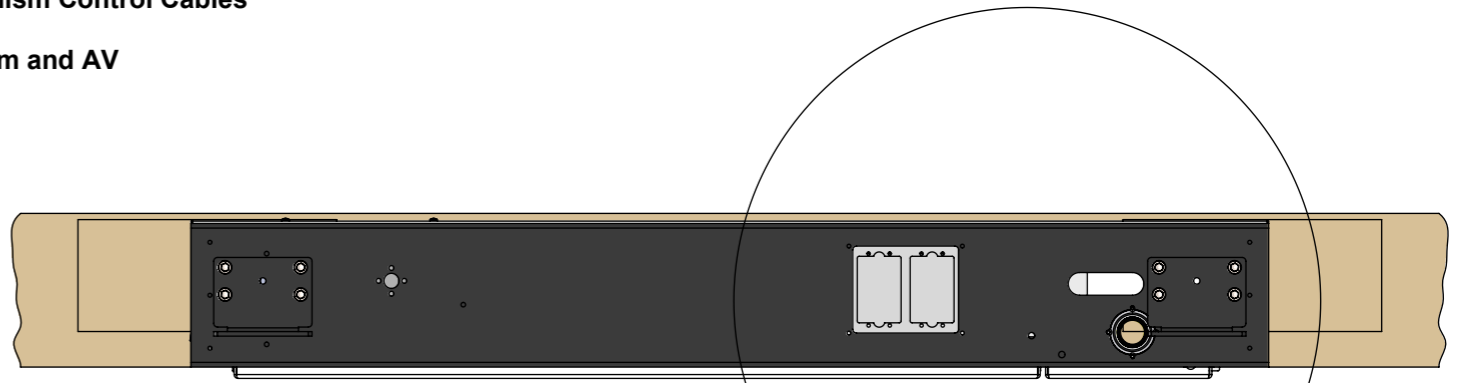

Ensure there are no obstructions around the power outlet mounting plate, between the mechanism and the mounting joist / ceiling structure

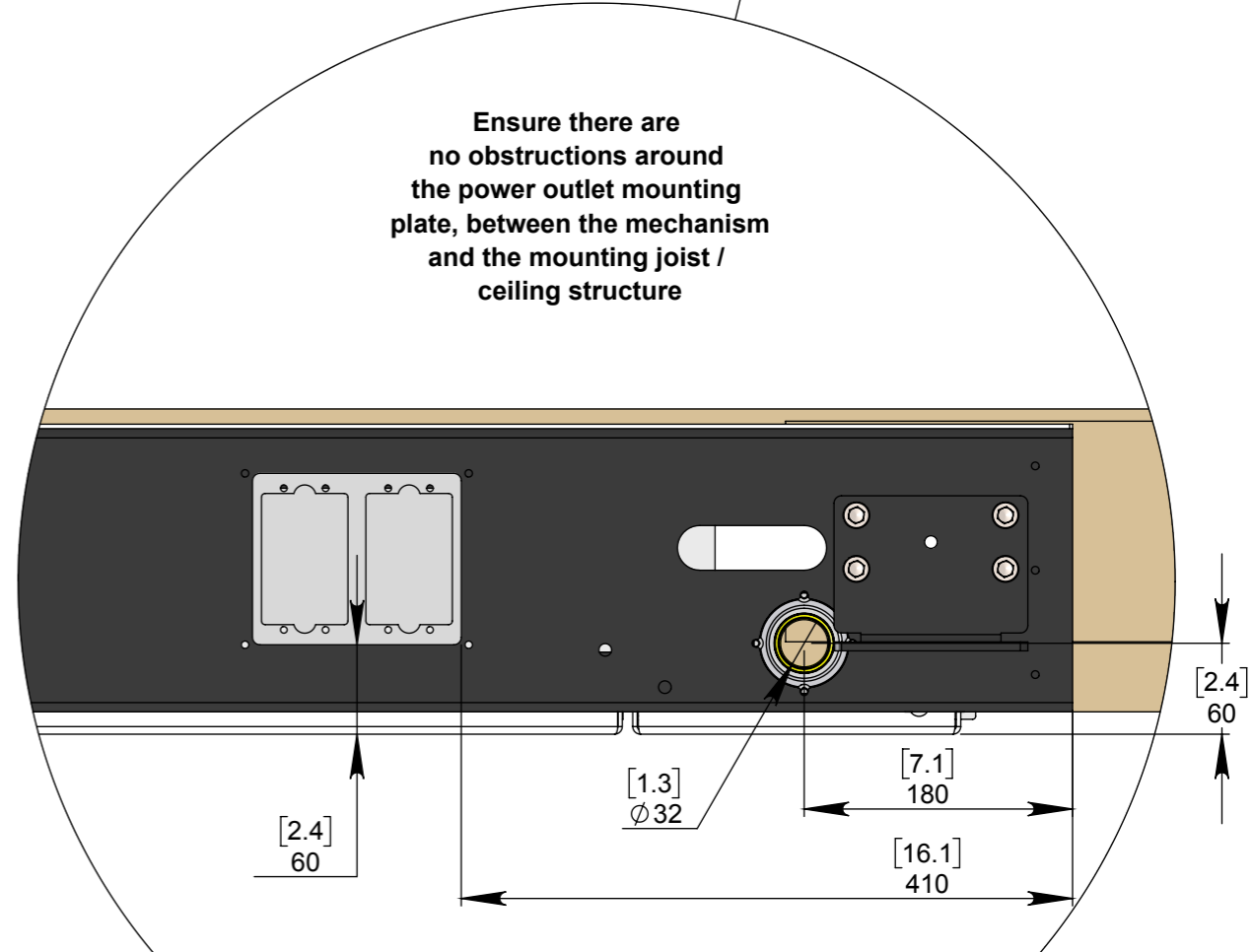

(Dimensions shown from rear of mechanism and underside of ceiling finish)

